

Brook ZERO-PI FIGHTING BOARD

Easy

USER GUIDE

ver.22.01

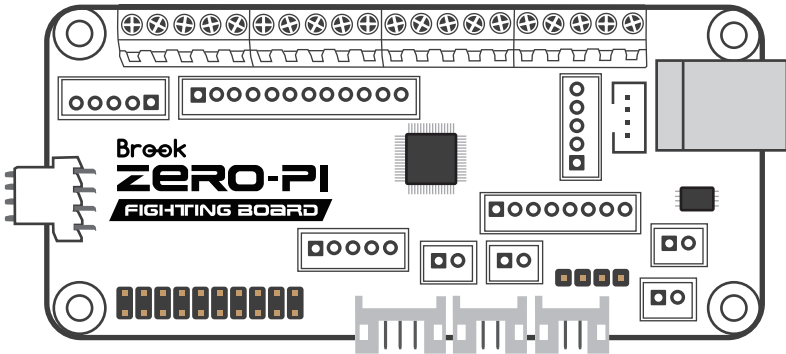

A-C1049-200701-V1.0



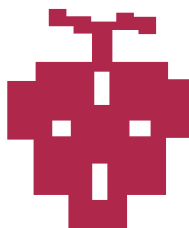





EN	Production induction	2
	Function	2
	How to connect	2
	J1(J1-1/J1-2/J1-3) USB for PS3	3
	J2(J3) LED Display	3
	Button configuration	3-4
	J4(J13+J14) header	5-6
	J16 Screw Terminal	6
	J7(J8+J11) Turbo Key function	6
	J12 How to switch between LS/RS/DP mode	7
	J15 For PS/PS2	8
	Use on PS3 and Switch	8
中文	產品介紹	9
	功能說明	9
	板面說明	9
	J1(J1-1/J1-2/J1-3) USB對應PS3	10
	J2(J3) LED顯示說明	10
	按鍵對應列表	10-11
	J4(J13+J14) 按鍵PIN OUT	12
	J16 端子台	13
	J7(J8+J11) Turbo Key功能	13
	J12 LS/RS/DP切換開關功能	14
	J15 對應PS/PS2	15
	在PS3和Switch上使用	15



Production induction

The ZERO-Pi fighting board supports to be used wired on NS/PS3/PS2/PS/PC(X-Input)/Retro Gaming System, it also supports LED, and turbo function.

Function

-  Support NS/PS3/PS2/PS/PC(X-Input)/Retro Gaming System
-  Support Player LEDs
-  Full-Compatible with BROOK Fighting Cable
-  Built-in SOCD cleaner
-  Different kinds connectors for USB
(USB Type-B/5-pin header connector/4-pin header connector/4-pin)
-  Effortless installation
-  Turbo Function
-  Upgradable Firmware

How to connect

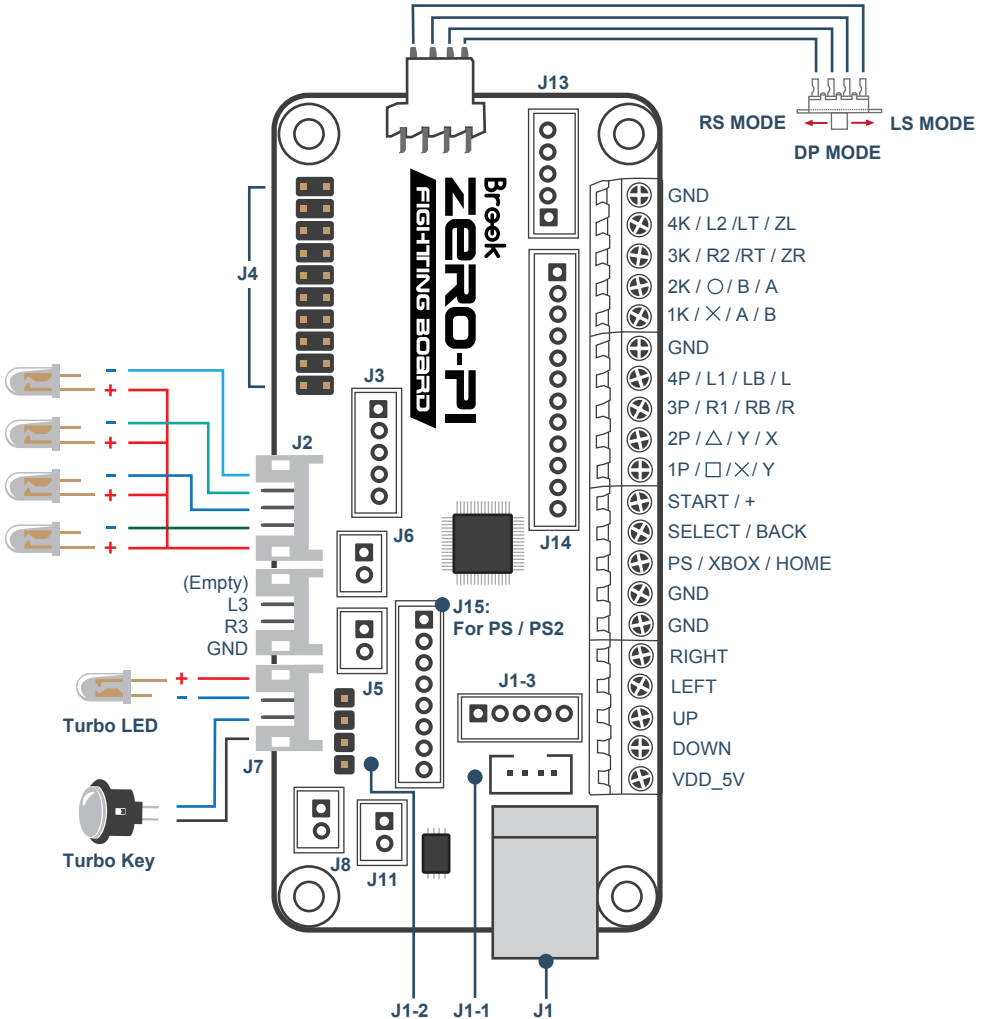

🎮 J1(J1-1/J1-2/J1-3) USB Connectors

Four usb connection selections for NS/PS3/PC(X-Input)/Retro Gaming Emulator

🎮 J2(J3) LED Display

Select J2 or J3 for Player LED

■ LED ON □ LED OFF

	PC	PS3	PS/PS2
1P	■ □ □ □	■ □ □ □	---
2P	□ ■ □ □	□ ■ □ □	■ ■ □ □
3P	□ □ ■ □	□ □ ■ □	---
4P	□ □ □ ■	□ □ □ ■	---
5P	---	■ □ □ ■	---
6P	---	■ □ □ ■	---
7P	---	■ □ □ ■	---

🎮 Button configuration

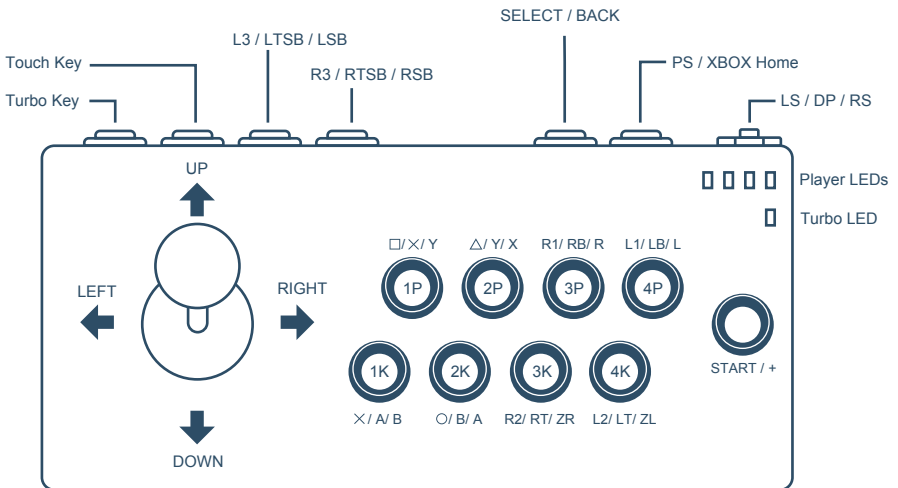

*Key function on stick: PS3/PC/Switch

PCB	Switch	PS3	PS2	PC
Stick in DP	D-PAD	D-PAD	D-PAD	POV
1P	Y	□	□	X
2P	X	△	△	Y
3P	R	R1	R1	RB
4P	L	L1	L1	LB
1K	B	×	×	A
2K	A	○	○	B
3K	ZR	R2	R2	RT
4K	ZL	L2	L2	LT
L3	LSB	L3	L3	LTSB
R3	RSB	R3	R3	RTSB
SELECT		SELECT	SELECT	BACK
START	+	START	START	START
	- (SELECT & 3P)			
	CAPTURE (SELECT & 4P)			
Home	Home	PS	PS	XBOX
Stick in LS	LX / LY	LX / LY	LX / LY	LX / LY
Stick in RS	RX / RY	RX / RY	RX / RY	RX / RY

J4(J13+J14) header

According to your preference to connect Brook Fighting Board Cable to J4 or J13 + J14

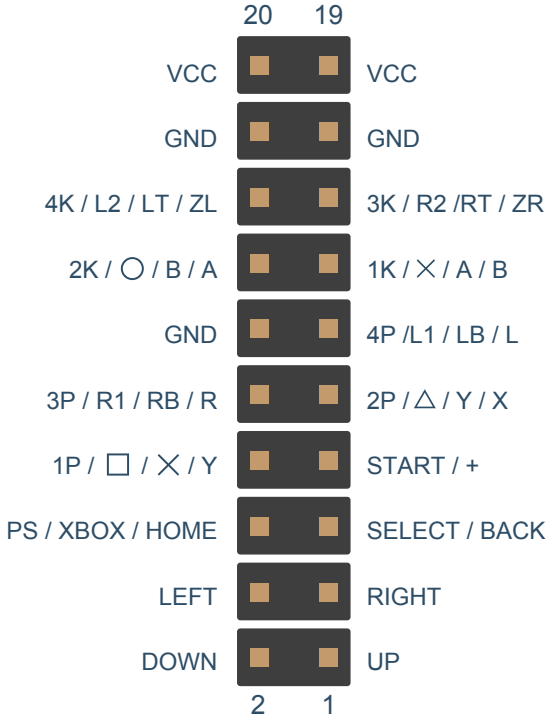

J16 Screw Terminal

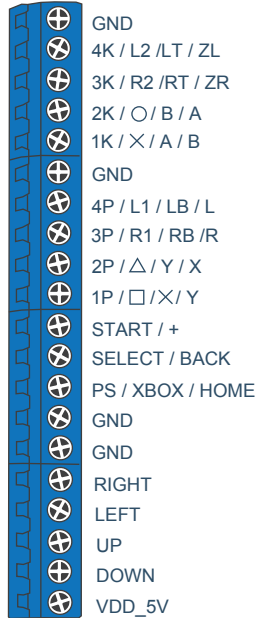

J7(J8+J11) Turbo Key function

Turbo available buttons: Δ , \bigcirc , \square , \times , L1, R1, L2, R2, L3, R3.
According to your preference to connect J7 or J18 + J11

●How to set and clear

To set: Hold down Turbo Key + turbo available buttons

To clear: Redo the procedure above again to clear turbo setting

When turbo LED is on, some turbo buttons have been set.

When turbo LED is off, no turbo buttons have been set.

When turbo LED is flashing, the pressed button has been set turbo.

J12 How to switch between LS/RS/DP

•Mode

LS, RS, DP Emulate (For J12 DP Mode Only)

For those who don't have LS,RS,DP switch, it's able to press combo keys for 3 seconds to switch between LS,RS,DP modes.

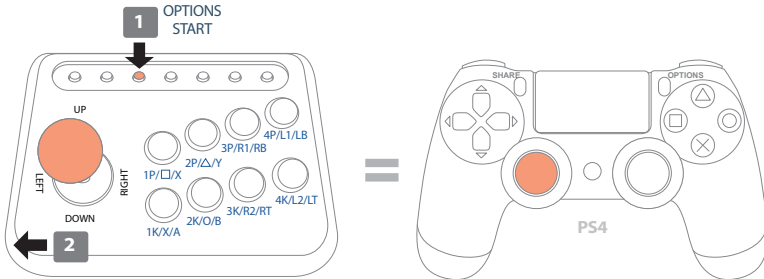

OPTIONS/ START + LEFT and press for 3 seconds

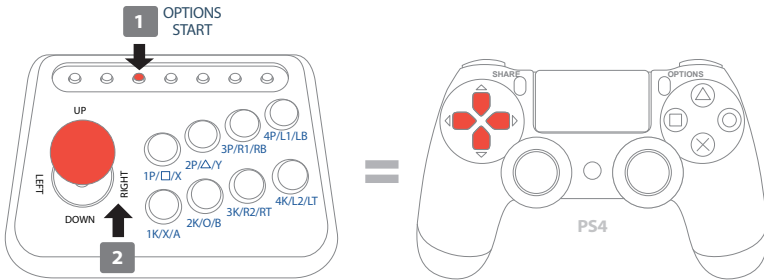

OPTIONS/ START + UP and press for 3 seconds
(default)

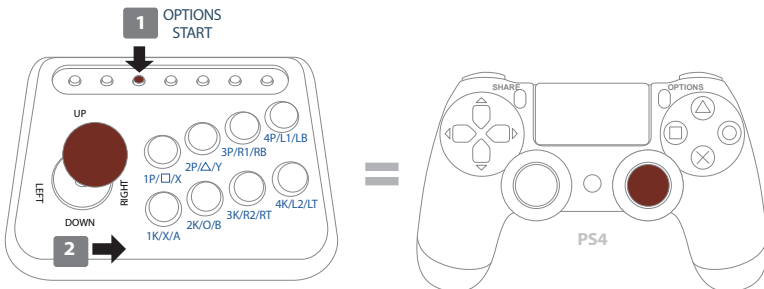

OPTIONS/ START + RIGHT and press for 3 seconds

J15 For PS/PS2

For connecting to PS/PS2

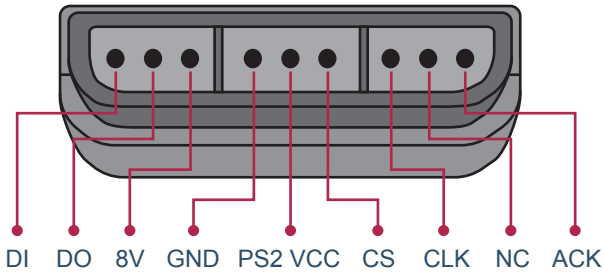
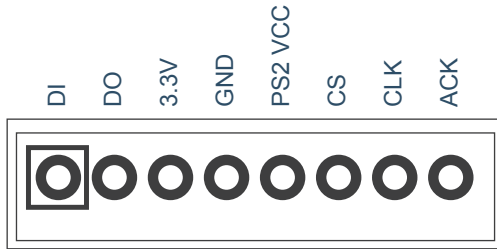

 Zero-Pi Fighting Board support auto-detect & manual to select Switch & PS3 consoles. If you want to switch mode manually, hold on following button then plug into consoles:

1P : PS3

1K : Switch

產品介紹

ZERO-Pi格鬥板支援NS/PS3/PS2/PS/PC(X-Input)主機與復古遊戲模擬器，允許你的大搖台以有線連接方式進行遊戲，支援LED與連射功能！

功能說明

- 支援NS/PS3/PS2/PS/PC(X-Input)主機與復古遊戲模擬器
- 支援使用者LED顯示
- 與BROOK Fighting Cable完美匹配
- 支援 SOCD cleaner
- 提供多種USB接頭 (USB Type-B/5-pin header connector/4-pin header connector/4-pin)
- 便利安裝設計
- 提供連發功能
- 輕鬆更新韌體

板面說明

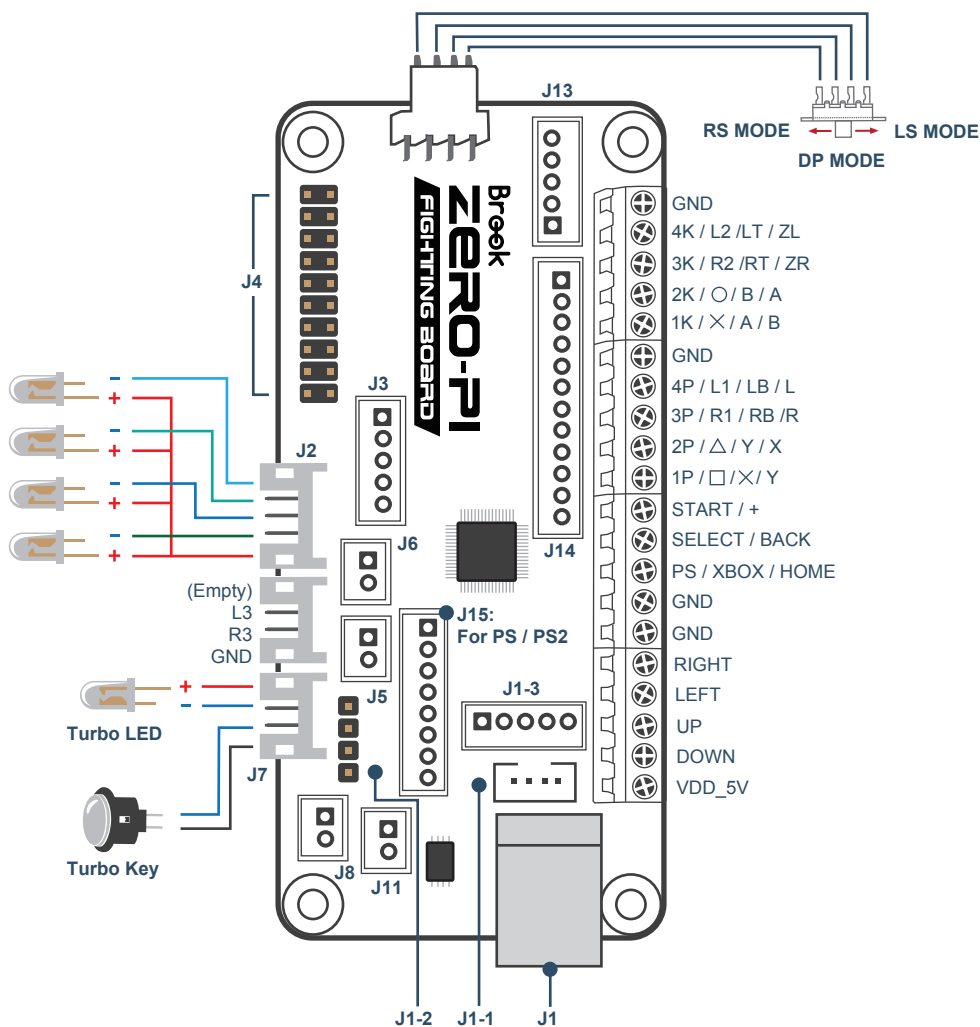

🎮 J1(J1-1/J1-2/J1-3) USB 接頭

ZERO-Pi Fighting Board提供四種不同的USB連接方式對應 NS/PS3/PC(X-Input)/Retro Gaming Emulator，可從中自行選用。

🎮 J2(J3) LED 顯示說明

J2與J3均為Player LED顯示功能，可從中自行選用。

■ LED ON □ LED OFF

	PC	PS3	PS/PS2
1P	■ □ □ □	■ □ □ □	---
2P	□ ■ □ □	□ ■ □ □	■ ■ □ □
3P	□ □ ■ □	□ □ ■ □	---
4P	□ □ □ ■	□ □ □ ■	---
5P	---	■ □ □ ■	---
6P	---	■ □ □ ■	---
7P	---	■ □ □ ■	---

🎮 按鍵對應列表

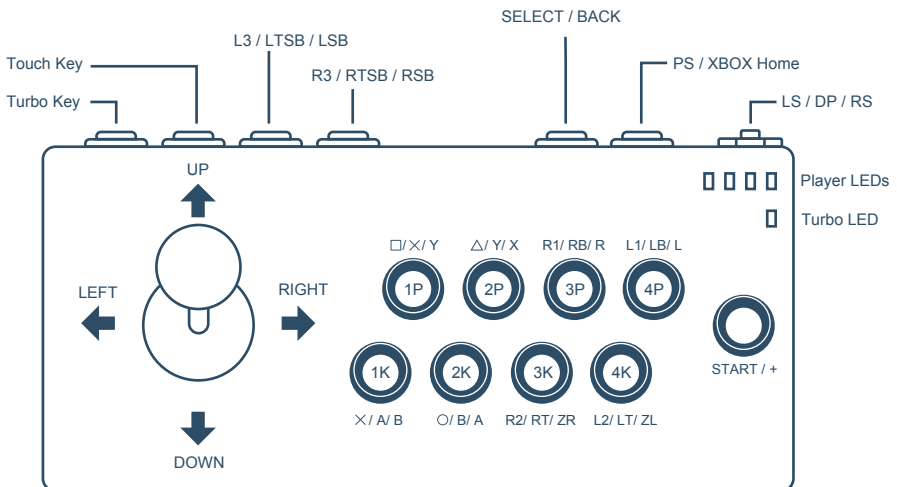

*Key function on stick: PS3/PC/Switch







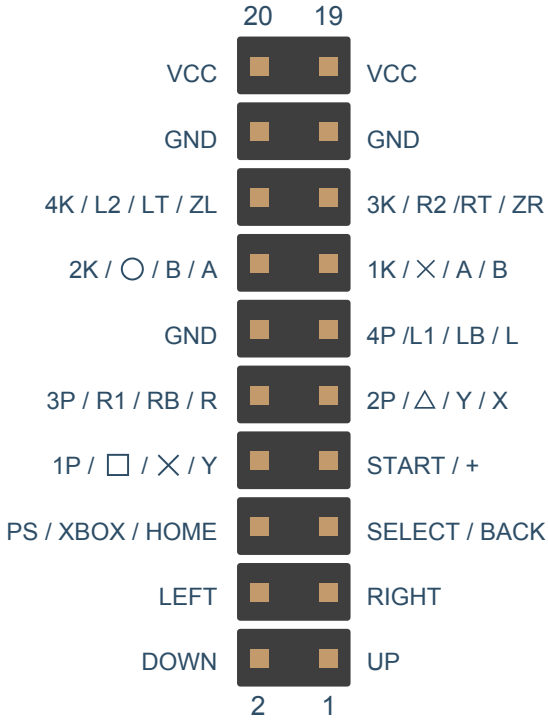













PCB	Switch	PS3	PS2	PC
Stick in DP	D-PAD	D-PAD	D-PAD	POV
1P	Y	□	□	X
2P	X	△	△	Y
3P	R	R1	R1	RB
4P	L	L1	L1	LB
1K	B	×	×	A
2K	A	○	○	B
3K	ZR	R2	R2	RT
4K	ZL	L2	L2	LT
L3	LSB	L3	L3	LTSB
R3	RSB	R3	R3	RTSB
SELECT		SELECT	SELECT	BACK
START	+	START	START	START
	- (SELECT & 3P)			
	CAPTURE (SELECT & 4P)			
Home	Home	PS	PS	XBOX
Stick in LS	LX / LY	LX / LY	LX / LY	LX / LY
Stick in RS	RX / RY	RX / RY	RX / RY	RX / RY

J4(J13+J14) 按鍵 PIN OUT

直接連接J4時推薦使用專用排線：Brook Fighting Board Cable。
根據您的需求也可使用J13加上J14來替代J4的功能。



J16 端子台

	GND
	4K / L2 / LT / ZL
	3K / R2 / RT / ZR
	2K / O / B / A
	1K / X / A / B
	GND
	4P / L1 / LB / L
	3P / R1 / RB / R
	2P / Δ / Y / X
	1P / □ / X / Y
	START / +
	SELECT / BACK
	PS / XBOX / HOME
	GND
	GND
	RIGHT
	LEFT
	UP
	DOWN
	VDD_5V

J7(J8+J11) Turbo Key 功能

可以設定Turbo的按鍵包括: Δ, O, □, X, L1, R1, L2, R2, L3, R3.

(按鍵對應請參考按鍵對應列表)。根據您的需求也可使用J8加上J11來替代J7的功能。

● 設定與清除方法

設定Turbo：按住Turbo Key + 可設定Turbo按鍵，即可使按鍵擁有Turbo功能。
重做一次則可清除按鍵上的Turbo設定。

Turbo_LED 恆亮時，代表有Turbo按鍵已被設定。

Turbo_LED 燈滅時，代表沒有任何按鍵被設定Turbo功能。

Turbo_LED 閃爍時，代表此按鍵已有Turbo功能。

J12 LS/RS/DP 切換開關功能

DP Mode (預設) : 搖桿輸入對應至D-pad輸出

LS Mode : 搖桿輸入對應至左3DVR (Lx、Ly) 輸出

RS Mode : 搖桿輸入對應至右3DVR (Rx、Ry) 輸出

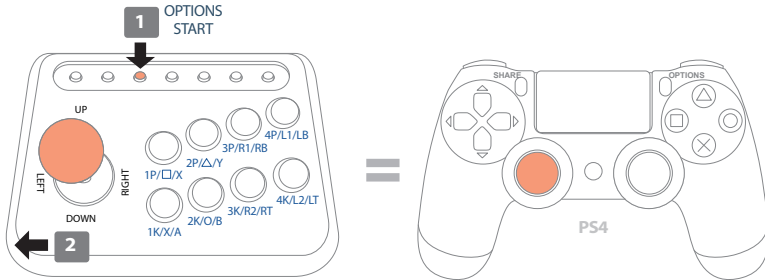

OPTIONS/ START + LEFT and press for 3 seconds

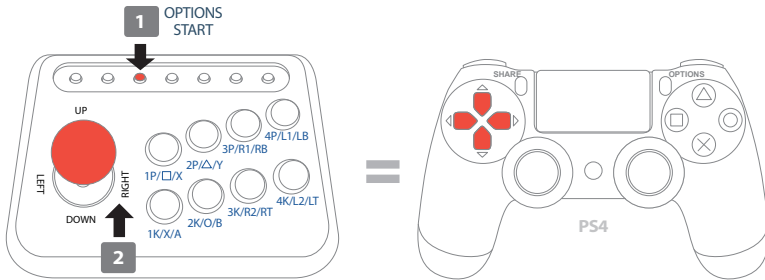

OPTIONS/ START + UP and press for 3 seconds
(default)

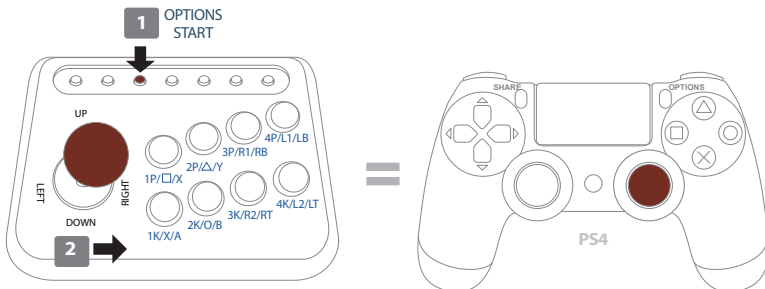

OPTIONS/ START + RIGHT and press for 3 seconds

J15 對應 PS/PS2

連接PS/PS2時請使用此接頭進行連接。

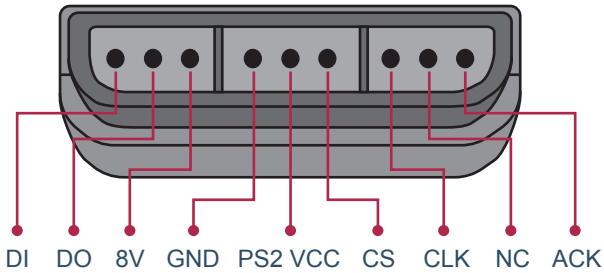
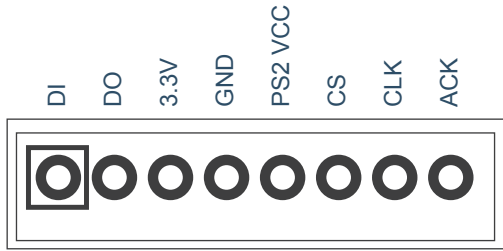

 Zero-Pi Fighting Board支援自動檢測和手動選擇Switch與PS3主機。
如果要手動切換模式，請按住以下按鈕，然後插入主機：

1P : PS3

1K : Switch

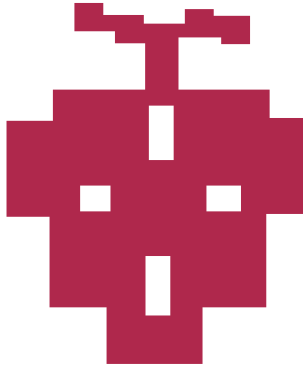

Brook Gaming series

Brook Design, LLC.

www.brookaccessory.com

Visit our website for more information and assistance

Copyright © Zeroplus Technology Co. Ltd All Rights Reserved
Brook is the registered trademark of Brook Design, LLC.
The other trademark names are the used marks, trademarks or registered trademarks of the corresponding companies.



Product Info